

COVER PLATES - RLM Range

SCREWLESS COVER PLATES FOR RAKO RCM OR RNC CONTROL MODULES



White Metal



Satin Stainless Steel



Polished Stainless Steel



Polished Brass



Black Nickel



Chocolate Bronze



Matt Black

Screwless cover plate options

The RLM range of screwless cover plates for the RCM and RNC 50x50mm push-button control modules are suitable for flush mount fixing into a standard 25mm deep UK back box, using the grid supplied.

RLM screwless cover plates are available in seven standard finishes - shown left. Custom finishes and double gang plates are subject to extended lead times. Plates are hand finished resulting in each plate being unique. Differences in colour of plate finishes shown in photos across Rako's website are due to lighting at the time of photography. Where engraving exposes natural brass the colour will organically age over time.

Cleaning Information

No abrasive or solvent-based treatment should be used. Plates, should only be cleaned with a soft, non abrasive dry cloth.

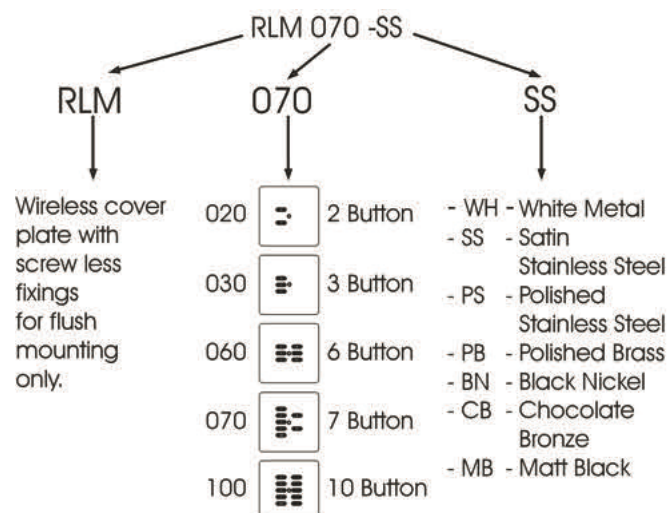
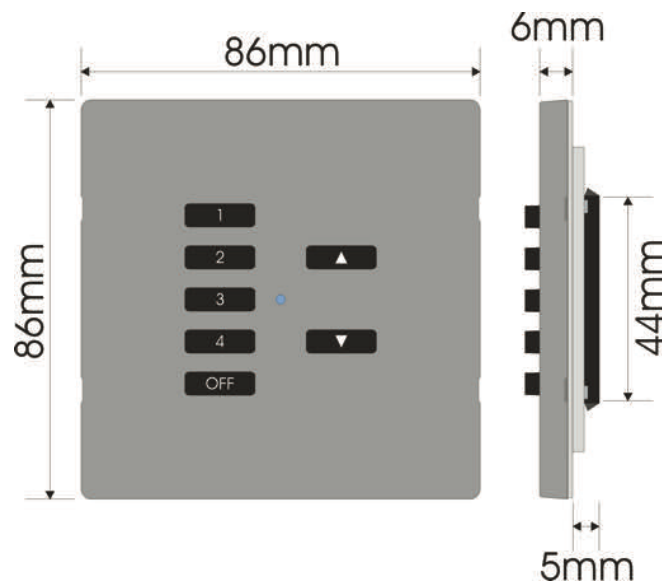

COVER PLATES - RLM Range

SCREWLESS COVER PLATES FOR RAKO RCM OR RNC CONTROL MODULES

Standard cover plate finishes

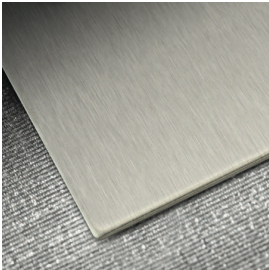

Satin Stainless Steel

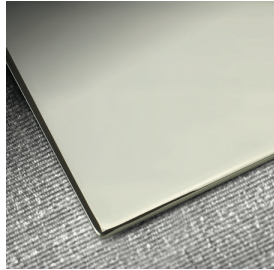

Polished Stainless Steel

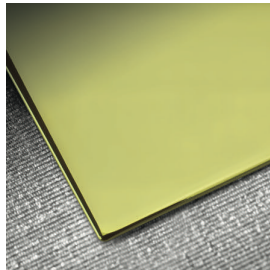

Polished Brass

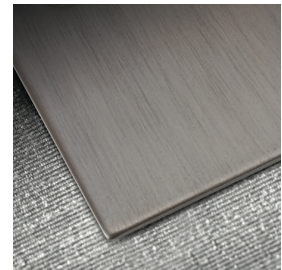

Chocolate Bronze

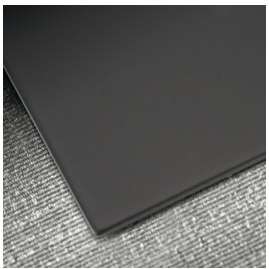

Matt Black



Matt White

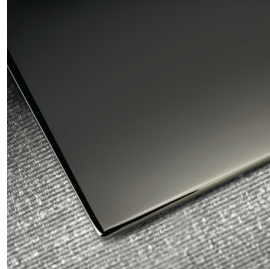

Black Nickel

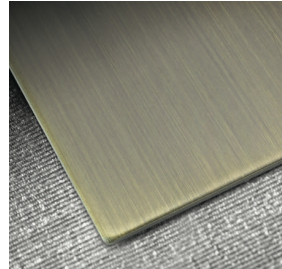

Antique Brass

Custom cover plate finishes - allow six weeks lead time.

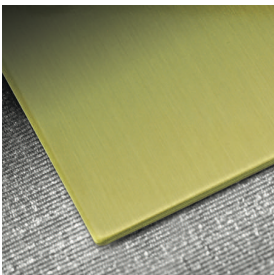

Satin Brass

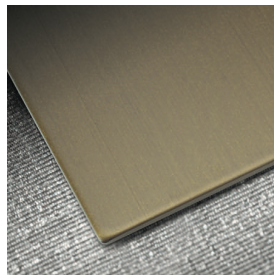

Bronze Antique

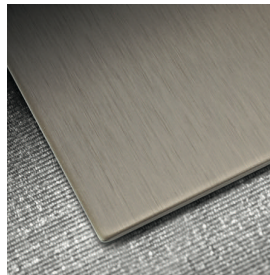

Bronze Satin Stainless

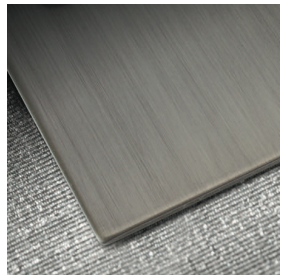

Jordan Bronze